

CORPORATE HEADQUARTERS

10601 West Belmont Avenue
Franklin Park, Illinois 60131 • U.S.A.
847.288.3300 • FAX: 847.288.3703
800.735.3867 (Toll-free within U.S.A., Canada)

www.lifefitness.com

INTERNATIONAL OFFICES

LIFE FITNESS ASIA PACIFIC LTD

Room 2610, Miramar Tower
132 Nathan Road
Tsimshatsui, Kowloon
HONG KONG
Telephone: (+852) 2891.6677
FAX: (+852) 2575.6001

LIFE FITNESS ATLANTIC BV LIFE FITNESS BENELUX

Bijdorpplein 25-31
2992 LB Barendrecht
THE NETHERLANDS
Telephone: (+31) 180.646.666
FAX: (+31) 180.646.699
Telephone: (+32) 87.300.942
FAX: (+32) 87.300.943

LIFE FITNESS DO BRAZIL

Av. Dr. Dib Sauaia Neto 1478
Alphaville, Barueri, SP
06465-140
BRAZIL
Telephone (+55) 11.4193.8282
FAX: (+55) 11.4193.8283

LIFE FITNESS VERTRIEBS GMBH

Dückerstraße 7-9/3/36
1220 Vienna
AUSTRIA
Telephone: (+43) 1.61 57 198
FAX: (+43) 1.61 57 198.20

LIFE FITNESS IBERIA

Pol. Ind. Molí dels Frares. c/C, nº 12
08620 Sant Vicenç dels Horts (Barcelona)
SPAIN
Telephone: (+34) 93.672.4660
FAX: (+34) 93.672.4670

LIFE FITNESS EUROPE GMBH

Siemensstraße 3
85716 Unterschleißheim
GERMANY
Telephone: (+49) 89.31 77 51.0
FAX: (+49) 89.31 77 51.99

LIFE FITNESS ITALIA S.R.L.

Via Vittorio Veneto, 57/A
39042 Bressanone (Bolzano)
ITALY
Telephone: (+39) 0472.835 470
FAX: (+39) 0472.833 150

LIFE FITNESS LATIN AMERICA and CARIBBEAN

10601 West Belmont Avenue
Franklin Park, Illinois 60131
U.S.A.
Telephone: (+1) 847.288.3300
FAX: (+1) 847.288.3886

LIFE FITNESS UK LTD

Queen Adelaide
Ely, Cambs CB7 4UB
UNITED KINGDOM
Telephone: (+44) 1353.666017
FAX: (+44) 1353.666018

LIFE FITNESS JAPAN

Nippon Brunswick Bldg., #8F
5-27-7 Sendagaya
Shibuya-Ku, Tokyo
JAPAN 151-0051
Telephone: (+81) 3.3359.4309
FAX: (+81) 3.3359.4307

Before using this product, it is essential to read this ENTIRE operation manual and ALL installation instructions.

This will help in setting up the equipment quickly and in instructing others on how to use it correctly and safely.

Avant toute utilisation de ce produit, il est indispensable de lire ce manuel d'utilisation dans son INTÉGRALITÉ, ainsi que TOUTES les instructions d'installations.

Ce manuel explique comment installer l'équipement et comment l'utiliser correctement et sans danger.

FCC Warning - Possible Radio / Television Interference

NOTE: *This equipment has been tested and found to comply with the limits for a Class A digital device, pursuant to part 15 of the FCC rules. These limits are designed to provide reasonable protection against harmful interference when the equipment is operated in a commercial environment. This equipment generates, uses and can radiate radio frequency energy, and if not installed and used in accordance with the operation manual, may cause harmful interference to radio communications. Operation of this equipment in a residential area is likely to cause harmful interference in which case the user will be required to correct the interference at his own expense.*

Class SB (Studio): Professional and / or commercial use.



CAUTION: Any changes or modifications to this equipment could void the product warranty.



MISE EN GARDE: Tout changement et toute modification de ce matériel peut annuler la garantie du produit.

Any service, other than cleaning or user maintenance, must be performed by an authorized service representative. There are no user-serviceable parts.

TABLE OF CONTENTS

Section	Description	Page
1.	Getting Started	5
1.1	Important Safety Instructions	5
1.2	Set-up	7
	Where to Place the Life Fitness® Stairclimber // How to Stabilize the Stairclimber // How to Charge Battery // Fitness and Entertainment Networking	
2.	The Display Console	10
2.1	The Display Console Overview	10
2.2	Display Console Descriptions	11
2.3	The Accessory Tray	14
3.	Heart Rate Zone Training Exercise	15
3.1	Why Heart Rate Zone Training Exercise?	15
3.2	Heart Rate Monitoring	16
	The Lifepulse™ Digital Heart Rate Monitoring System // The Polar® Telemetry Heart Rate Monitoring Chest Strap	
4.	The Workouts	18
4.1	Workout Overviews	18
4.2	Using the Workouts	20
	To Begin any Workout // Selecting Quick Start // Selecting a Workout // Entering Weight // Entering Age // Entering Time // Selecting and Adjusting the Intensity Level // Selecting a Goal Type // Switching Workouts “On-the-Fly” // Pausing Workouts // Ending Workouts Early // Life Fitness Stairclimber Workout Setup Steps (chart)	
4.3	Workout Descriptions	24
	Quick Start // Fat Burn // Cardio // Hill // Random // Manual // Heart Rate Hill™ Workout // Heart Rate Interval™ Workout // Extreme Heart Rate™ Workout // Watts // Mets // Six Pre-Set Workouts	
4.4	Personal Trainer Workouts	28
	Using Personal Trainer Workouts // Creating a Personal Trainer Workout	
4.5	Using the Life Fitness Stairclimber	29
	Stairclimber Motion // Posture During Workouts // Braking Resistance	
5.	Optional Settings	30
5.1	Entering and Using the Optional Settings Feature	30
6.	Service and Technical Data	31
6.1	Preventative Maintenance Tips	31
6.2	Inspecting and Cleaning the Stairclimber	32
6.3	Troubleshooting the Lifepulse System Sensors	32
6.4	Troubleshooting the Polar Heart Rate Chest Strap	32
	Heart Rate Reading is Erratic or Absent Entirely // Heart Rate Reading is Erratic or Extremely High	
6.5	How to Obtain Product Service	33
7.	Specifications	34
7.	Life Fitness 9500HR Stairclimber Specifications	34

© 2002 Life Fitness®, a division of Brunswick Corporation. All rights reserved. Life Fitness and Zone Training are registered trademarks of Brunswick Corporation. Zone Training+, Heart Rate Hill, Heart Rate Interval, Extreme Heart Rate, and Lifepulse are trademarks of Brunswick Corporation. Polar is a registered trademark of Polar Electro, Inc. Cardio Theater is a registered trademark of the Cardio Theater Holdings. FitLinxx is a registered trademark of the Integrated Fitness Corp. Any use of these trademarks, without the express written consent of Life Fitness or the corresponding companies is forbidden.

This Operation Manual describes the functions of the following products:

Life Fitness stairclimber:

9500HR

See Section 7, titled *Specifications* page in this manual for product-specific features.

Statement of Purpose: The Life Fitness stairclimber is an exercise machine that simulates the movements of walking up stairs at various speeds.



CAUTION: Life Fitness STRONGLY recommends seeing a physician for a complete medical exam before undertaking an exercise program, particularly if the user has a family history of high blood pressure or heart disease is over the age of 45, smokes, has high cholesterol, is obese, or has not exercised regularly in the past year.

If, at any time while exercising, the user experiences faintness, dizziness, pain, or shortness of breath, he or she must stop immediately.



MISE EN GARDE: Life Fitness conseille VIVEMENT de consulter un médecin pour subir un examen médical complet avant de commencer tout programme d'exercice, et tout particulièrement si l'utilisateur a des antécédents familiaux d'hypertension ou de troubles cardiaques, ou s'il a plus de 45 ans, s'il fume, s'il a du cholestérol, s'il est obèse ou n'a pas fait d'exercice régulièrement depuis un an.

Si, pendant l'utilisation de l'appareil, l'utilisateur ressent un malaise, des vertiges, des douleurs ou des difficultés à respirer, il doit cesser immédiatement.

1 GETTING STARTED

1.1 IMPORTANT SAFETY INSTRUCTIONS



SAFETY WARNING: The safety of the product can be maintained only if it is examined regularly for damage and wear. See Preventative Maintenance section for details.

- Use this appliance only for its intended use as described in this manual. Do not use attachments that have not been recommended by the manufacturer.
- If the Life Fitness stairclimber has been dropped, damaged, or partially immersed in water, contact Life Fitness Customer Support Services and do not use the unit.
- Be very careful not to allow other people to interfere in any way with the user or equipment while their exercise routine is in progress.
- Always follow the console instructions for proper operation.
- Close supervision is necessary when used near children, invalids or disabled persons.
- Do not use the Life Fitness stairclimber outdoors, near swimming pools, or in areas of high humidity.
- Never insert objects into any opening of the product. If an object should drop inside, carefully retrieve it while the unit is not in use. If the object cannot be reached, contact Life Fitness Customer Support Services.
- Never place liquids of any type directly on the unit, except in an accessory tray or holder. Containers with lids are recommended.
- Wear shoes with rubber or high-traction soles. Do not use shoes with heels, leather soles, cleats, or spikes. Make sure no stones are embedded in the soles.
- Do not use this product with bare feet.
- Keep all loose clothing, shoelaces, and towels away from moving parts.
- Do not reach into, or underneath, the unit or tip it on its side during operation.
- Keep the area around the Life Fitness stairclimber clear of any obstructions, including walls and furniture. Provide at least three feet of clearance behind the unit.
- Use caution when stepping on or off of the Life Fitness stairclimber.
- Never face backward while using the product.
- An American Society for Testing and Materials (ASTM) safety sign has been shipped with the Life Fitness stairclimber. Post the sign in a visible area near the unit.

SAVE THESE INSTRUCTIONS FOR FUTURE REFERENCE.

1 POINT DE DÉPART

1.1 CONSIGNES DE SÉCURITÉ IMPORTANTES



CONSIGNE DE SÉCURITÉ : pour un emploi sûr, le produit doit être inspecté régulièrement afin de s'assurer qu'il n'est pas usé ni endommagé. Consultez la section de Maintenance préventive pour obtenir de plus amples informations.

- Cet appareil ne doit être employé que pour l'usage auquel il est destiné, conformément aux directives de son manuel. N'utilisez pas d'accessoires qui ne seraient pas recommandés par le fabricant.
- **Ne faites jamais fonctionner d'appareil Life Fitness dont le cordon d'alimentation ou la fiche seraient abîmés, qui aurait fait une chute ou qui aurait été endommagé ou partiellement plongé dans l'eau. Contactez le service après-vente de Life Fitness.???**
- Assurez-vous que personne ne gêne l'utilisateur ou ne nuise au fonctionnement de l'appareil pendant qu'il fonctionne.
- Pour un fonctionnement correct, suivez toujours les instructions de la console.
- Une surveillance étroite est nécessaire en cas d'utilisation par des enfants, des personnes invalides ou handicapées.
- N'utilisez pas ce produit à l'extérieur, près d'une piscine ou dans des endroits très humides.
- N'insérez jamais d'objet dans les ouvertures de cet appareil. Si un objet tombe dedans, coupez l'alimentation électrique, débranchez le cordon de la prise et récupérez-le avec précaution. Si vous ne pouvez pas l'atteindre, consultez le service après-vente de Life Fitness.
- Ne placez jamais de liquides d'aucune sorte directement sur l'appareil, sauf si vous disposez d'un support ou d'un plateau pour accessoires. Il est recommandé d'utiliser des verres munis d'un couvercle.
- Portez des chaussures avec semelles en caoutchouc ou antidérapantes. N'utilisez pas de chaussures à talons, de semelles en cuir ou à crampons. Assurez-vous qu'aucun caillou ne s'est incrusté dans les semelles.
- N'utilisez pas cet appareil sans chaussures.
- Maintenez les vêtements lâches, les lacets et les serviettes à l'écart des pièces en mouvement.
- Ne placez pas les mains sous ou dans l'appareil, et ne le renversez pas sur le côté pendant le fonctionnement.
- Maintenez la zone autour du produit Life Fitness exempte d'obstructions, y compris de murs et de meubles. Veillez à laisser au moins 30 cm d'espace autour du Life Fitness stairclimber.
- Procédez avec précaution lors du montage ou du démontage du Life Fitness stairclimber.
- N'utilisez jamais cet appareil en vous tournant vers l'arrière.
- **An American Society for Testing and Materials (ASTM) safety sign has been shipped with the Life Fitness stairclimber. Post the sign in a visible area near the unit.**

CONSERVEZ CES INSTRUCTIONS POUR USAGE ULTÉRIEUR.

1.2 SETUP

Read the entire Operation Manual before setting up the Life Fitness stairclimber.

WHERE TO PLACE THE LIFE FITNESS® STAIRCLIMBER

Following all safety instructions in Section 1.1, move the unit to the location in which it will be used. See Section 7, titled *Specifications*, for the dimensions of the footprint. Allow a distance of 8 inches, or 21 centimeters, between the Life Fitness stairclimber and other units on either side. Allow a distance of 3 feet, or 1 meter, from the rear of the unit to any object or surface.

HOW TO STABILIZE THE LIFE FITNESS STAIRCLIMBER

After placing the Life Fitness stairclimber in position, check the unit's stability by attempting to rock it in all directions. Any slight rocking indicates that the unit must be leveled. Determine which foot is not resting completely on the floor. Loosen the jam nut (B) with an open-end 9/16-inch wrench, and rotate the stabilizing foot (A) to lower it. Verify that the unit is stable, and repeat the adjustment as necessary until the unit no longer rocks. Lock the adjustment by tightening the jam nut against the stabilizer bar.

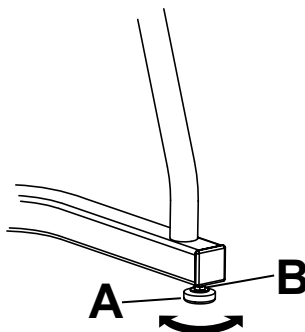

HOW TO CHARGE THE BATTERY

The Life Fitness stairclimber is powered by a rechargeable 6V battery. Check the battery by pressing the START key or by stepping on the pedals. If the battery is charged, the console lights up, making it possible to program a workout. See section 4, titled *The Workouts*, for detailed information on programming workouts. If the display console does not light up, the unit must be re-charged. To do so, use the optional plug-in charging unit. The charger should be connected to the stairclimber for a minimum of eight hours to ensure a thorough charge. The unit may be used while the battery is being charged.

Life Fitness recommends charging the unit overnight at least once per week to ensure a long life for the battery under the following conditions:

- The stairclimber is operated consistently by users who weigh less than 120 pounds
- Workout durations are consistently less than 20 minutes
- Usage is less than the hours per day

To recharge the stairclimber battery, first plug the charger's AC cord into an electrical outlet. Then plug the charging cable into the stairclimber jack, which is located at the front of the unit, near the floor. Consult the chart below for international electrical requirements. *

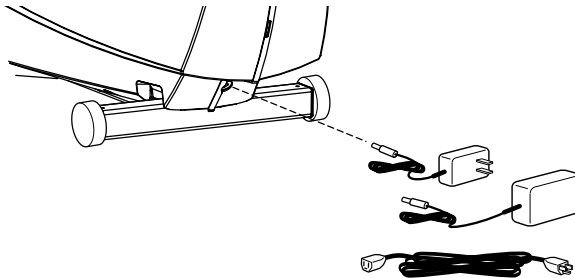

The plug must be inserted into an electrical outlet that has been properly installed and grounded in accordance with all local codes and ordinances.

**If the console display does not light up after the proper charging procedure is followed, call Customer Support Services.*

Location	Voltage	Frequency Hz	Current AMPs
United Kingdom	230	50	1
Federal Republic of Germany, France, Netherlands, Italy, Chile, Belgium, Korea, Argentina, Spain	230	50	1
Latin America	110/220	60	1
Japan	200	50/60	1
Australia	240+	50	1
U.S., Canada	120	60	1

FITNESS AND ENTERTAINMENT NETWORKING

Two interchangeable network ports allow the Life Fitness stairclimber to be connected to a fitness entertainment system and/or a network, such as the FitLinxx™ interactive fitness network.

- **Fitness network:** The network connection enables the console to upload user workout statistics to a fitness network database or to download remotely stored information, such as a pre-set workout program. See Section 4.2, titled *Using the Workouts*, for information on logging onto a network.
- **Entertainment:** The network connection enables the console to power third-party equipment for use with a service such as the Cardio Theater® entertainment system or the BroadcastVision™ entertainment system. With the purchase of the Entertainment Controls Kit, the stairclimber is enhanced to include volume and channel controls. To order the kit, call Life Fitness Customer Support Services. See Section 6.5, titled *How to Obtain Product Service*.

The network ports are located on the back of the console and are enclosed by a removable cover. Any use of the ports for other than their intended purpose could void the product warranty.

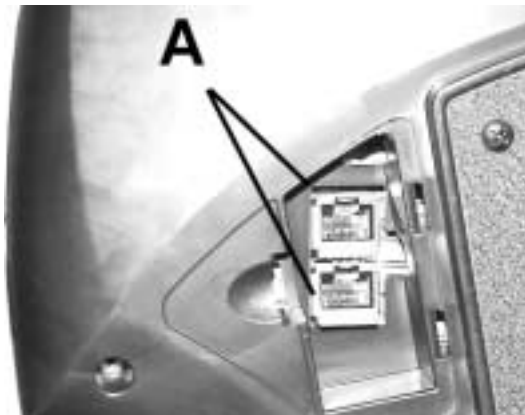

2 THE DISPLAY CONSOLE

2.1 DISPLAY CONSOLE OVERVIEW

The computerized display console allows the user to tailor a workout to personal fitness abilities and goals and to monitor progress. With this easy-to-use console, the user can track fitness improvement from one workout to the next.

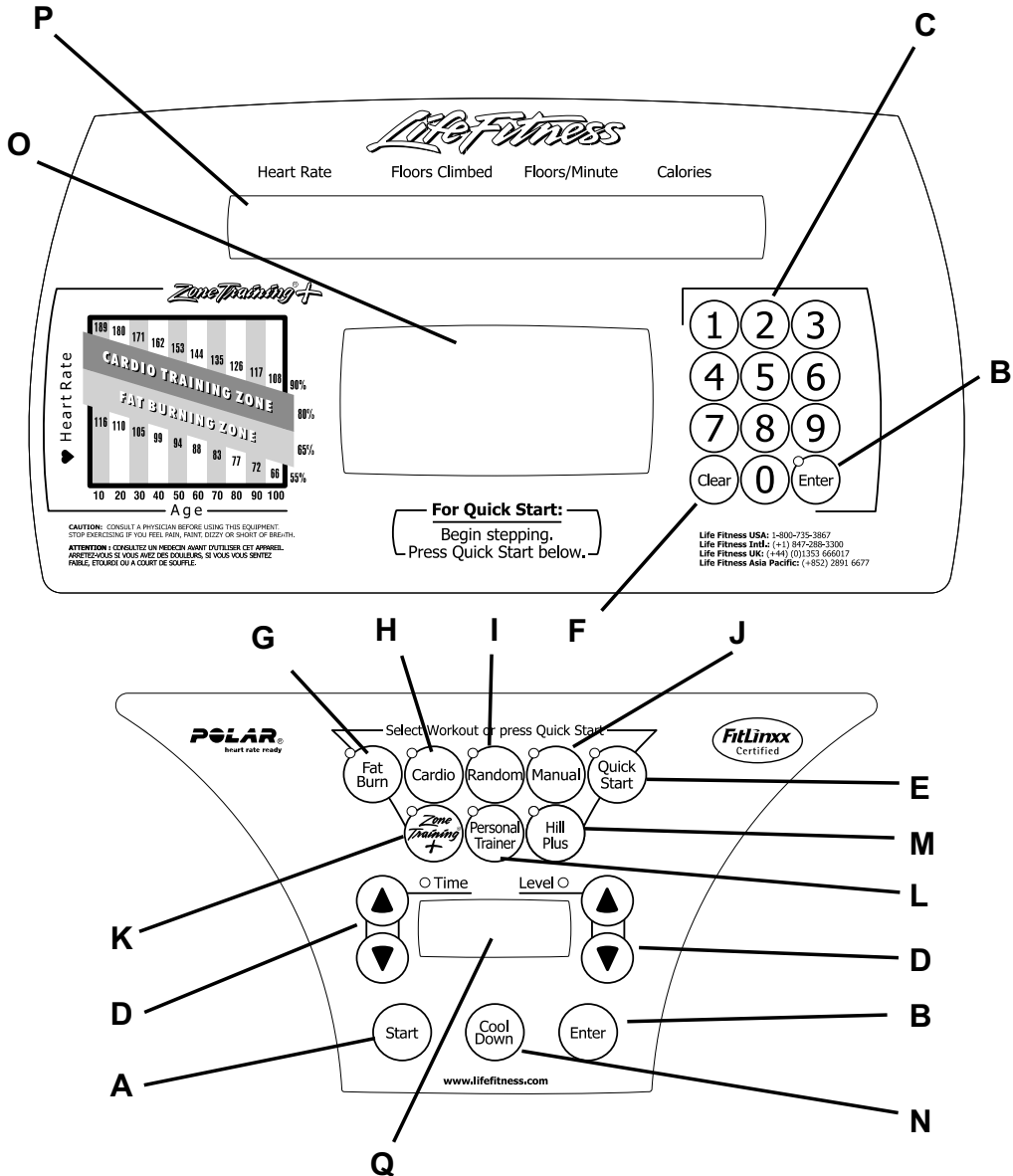

2.2 DISPLAY CONSOLE DESCRIPTIONS

This section lists and describes the functions for the keys and display windows on the Life Fitness stairclimber console. See Section 4, titled *The Workouts*, for detailed information on using the console to set up workouts.

- A START:** Press this key to activate the console for programming a new workout. The activated console lights up and displays **SELECT WORKOUT OR PRESS QUICK START**. If no key is pressed, the console shuts down again.
NOTE: *The AutoStart feature activates the console when the user steps on the pedals.*
- B ENTER:** Press this key after entering each value, such as weight or workout time, when prompted by console display messages.
- C NUMERIC keypad:** Use these keys to enter values, such as length of workout, weight, age, target heart rate, and intensity level. While a workout is in progress, numeric keys can be used to set new intensity levels or change the target heart rate in the **FAT BURN**, **CARDIO**, **HEART RATE HILL**, **HEART RATE INTERVAL**, and **EXTREME HEART RATE** workouts. The **ARROW** keys have a similar function, except that they change workout parameters by single increments.
- D ARROW keys:** A pair of **UP** and **DOWN** arrows is located on either side of the **TIME/LEVEL** window. Use either set of arrows, when setting up a workout, to change workout parameters displayed on the console, such as length of workout, weight, age, target heart rate, and intensity level. During a workout, pressing the **ARROWS** on the right (**LEVEL**) side of display changes the target heart rate for **FAT BURN**, **CARDIO**, **HEART RATE HILL**, **HEART RATE INTERVAL**, and **EXTREME HEART RATE** workouts or the intensity level for other workouts. Pressing the **ARROWS** on the left (**TIME**) side increases or decreases the workout duration.
- E QUICK START:** Press this key to begin a manual workout immediately, without having to select a workout. Once the workout is in progress, use the **ARROW** keys or the **NUMERIC** keypad to change the intensity level or workout duration as desired.
- F CLEAR:** Press this key, when programming a workout, to clear incorrect data, such as weight or age, before pressing the **ENTER** key. Pressing **Clear** during a workout stops it immediately, at which point, the **MESSAGE CENTER** displays a summary of the workout, including total time elapsed, total calories burned, and total floors climbed. Pressing **CLEAR** a second time causes the **Message Center** to prompt the user for a new workout setup.
- G FAT BURN:** Press this key to select the **FAT BURN** workout, which is a low-intensity workout for burning fat.
- H CARDIO:** Press this key to select the **CARDIO** workout, which is a higher intensity workout for more fit users, emphasizing cardiovascular benefits and maximum fat burning.
- I RANDOM:** Press this key to select the **RANDOM** workout, which is a workout of constantly changing intensity levels that occur in no regular pattern or progression.
- J MANUAL:** Press this key to select the **MANUAL** workout, in which the intensity level remains the same unless it is manually changed.

- K ZONE TRAINING+:** Press this key to select one of the Zone Training+™ workouts, which target specific ranges, or zones, for maintaining a heart rate to achieve maximum exercise results. The following options may be accessed with this key:
- **HEART RATE HILL**
 - **HEART RATE INTERVAL**
 - **EXTREME HEART RATE**
 - **FAT BURN**
 - **CARDIO**
 - **TIME IN ZONE GOAL**
- L PERSONAL TRAINER:** Press this key to select a customized workout designed by a fitness club trainer or staff member. For detailed information about the workouts, Section 4, titled *The Workouts*. See Section 4.4 for information on designing **PERSONAL TRAINER WORKOUTS**. The following workouts may be accessed with the PERSONAL TRAINER key:
- **METS**
 - **WATTS**
 - **CALORIE GOAL**
 - **DISTANCE GOAL**
 - **PERSONAL TRAINER WORKOUTS** (6 slots)
- M HILL PLUS:** Press this key to select **HILL PLUS** workouts, in which intensity levels increase and decrease in a set pattern. For detailed information about the workouts, Section 4, titled *The Workouts*. The following workouts may be accessed with this key:
- **HILL**
 - **AROUND THE WORLD**
 - **KILIMANJARO**
 - **INTERVAL**
 - **CASCADES**
 - **SPEED TRAINING**
 - **FOOT HILLS**
- N COOL DOWN:** workouts end automatically in a Cool Down mode, which lowers the intensity level. Press the COOL DOWN key at any desired point during a workout to go immediately into Cool Down mode. In this phase of a workout the body begins to remove lactic acid and other accumulated by-products of exercise, which build up in muscles during a workout and contribute to muscle soreness. The console automatically adjusts each workout's Cool Down level according to the individual user's performance. Each time the user presses the COOL DOWN key, the Cool Down duration shortens by one minute.

- O WORKOUT PROFILE WINDOW:** This window displays shapes, made of columns of lights, that represent the levels of intensity in a workout-in-progress. The height of the column is proportional to the level of the intensity.

During a **FAT BURN, CARDIO, HEART RATE HILL, HEART RATE INTERVAL, or EXTREME HEART RATE** workout, which requires the use of the Lifepulse system sensors or a Polar® heart rate chest strap, the WORKOUT PROFILE window displays a heart shape to request the user's heart rate signal. If the console does not detect a signal, the MESSAGE CENTER displays the prompt, "NEED HEART RATE - PLACE HANDS ON SENSORS OR USE TELEMETRY STRAP". If the console does not receive the signal within three minutes, the workout automatically is converted to a **MANUAL** workout. Profiles are not available for **FAT BURN, CARDIO, HEART RATE HILL, HEART RATE INTERVAL, or EXTREME HEART RATE**. In these workouts, the level is based on the heart rate. Therefore, the profile cannot be displayed.

- P MESSAGE CENTER:** This window displays step-by-step instructions for setting up a workout. During a workout, it displays statistics about the progress of the workout:
- **Floors/Minute:** the rate of floors climbed per minute.
 - **Calories:** the number of calories burned since beginning the workout; based on a calculation involving the entered weight of the user and the step rate. If the user does not enter weight during the workout setup, the computer does not make this calculation.
 - **Heart Rate:** the detected heart rate if the user is gripping the Lifepulse system sensors or wearing the chest strap.
 - **Floors Climbed:** the total number of floors climbed.

If programmed to do so, the MESSAGE CENTER displays any or all of these three values each time the intensity level changes during the workout:

- **Calories per Hour:** the rate of calories burned per hour.
 - **Watts:** effort level in Watts. The Watt is a unit of power output or the expression of the mechanical rate of work.
 - **Mets:** effort level in Mets. The Met is an expression of the rate of work for the human body, or a metabolic equivalent; one Met is approximately equal to the metabolism of a person at rest.
- Q LEVEL/TIME WINDOW:** This window displays the programmed intensity level and the time elapsed since the start of the workout.

2.3 THE ACCESSORY TRAY

The accessory tray (A), which is mounted to the base of the console, provides dual storage trays with space for items such as water bottles, personal stereos, and cell phones. Additionally, an integrated reading rack (B) for supporting a book or magazine is located at the base of the upper panel of the console.

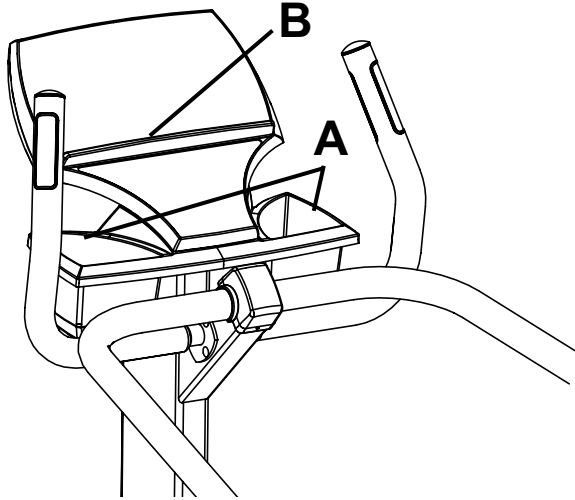

3 HEART RATE ZONE TRAINING EXERCISE

3.1 WHY HEART RATE ZONE TRAINING EXERCISE?

Research shows that maintaining a specific heart rate while exercising is the optimal way to monitor the intensity of a workout and to achieve maximum results. That is the idea behind the Life Fitness heart rate zone training approach to exercise.

Zone training identifies an exerciser's ideal heart rate range, or zone, for burning fat or increasing cardiovascular fitness. The values within the zone depend on the workout.

NOTE: Consulting a fitness trainer is recommended for defining specific fitness goals and designing a workout program.

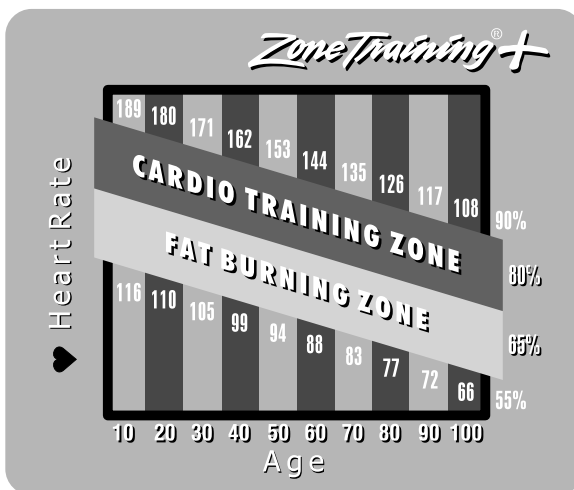

The Life Fitness stairclimber features exclusive workouts designed to take full advantage of the benefits of heart rate zone training exercise: **FAT BURN**, **CARDIO**, **HEART RATE HILL**, **HEART RATE INTERVAL**, and **EXTREME HEART RATE**. The Time in Zone Goal option, another feature of heart rate zone training, enhances these workouts by setting a certain duration within the target zone as a workout goal. For detailed information about the workouts, as well as the Time In Zone Goal option, see Section 4, titled *The Workouts*.

During one of these workouts, grasp the Lifepulse system sensors continuously, or wear the Polar heart rate chest strap to enable the Life Fitness stairclimber's on-board computer to monitor the heart rate during a workout. The computer automatically adjusts the resistance level to maintain the target heart rate* based on the actual heart rate. To change the target heart rate during a workout, use the LEVEL ARROW keys or the NUMERIC keypad.

* Target Heart Rate (THR) is a percentage of the theoretical maximum. For example, a 40-year-old user's THR for the **CARDIO** workout is 144. This workout targets 80 percent of the maximum, so the equation would be $(220-40) \cdot 80=144$. A 20-year-old user's THR is 160, so the equation would be $(220-20) \cdot 80=160$.

3.2 HEART RATE MONITORING

THE LIFEPULSE™ DIGITAL HEART RATE MONITORING SYSTEM

The patented Lifepulse system sensors are the built-in heart rate monitoring system on the Life Fitness stairclimber. Grasp the stainless steel sensors (A) that are set into the “bull horn” handlebars. The console displays the heart rate after 10 to 40 seconds.

Grasp both sensors (A) on each handlebar comfortably for the console to obtain an accurate heart rate reading.

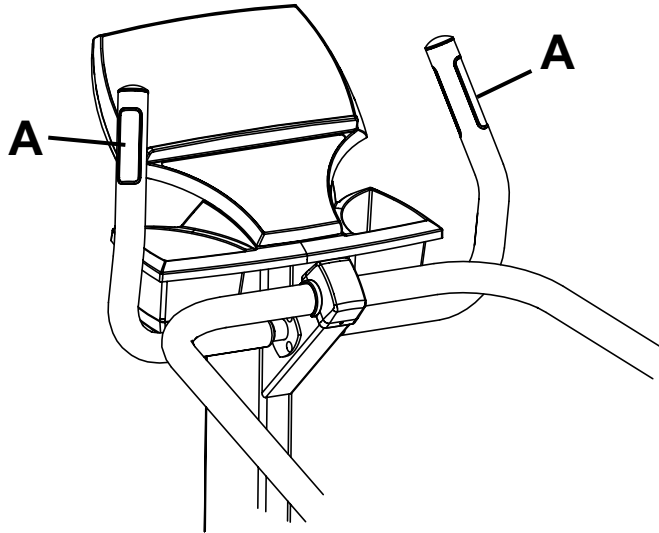

THE POLAR® TELEMETRY HEART RATE MONITORING CHEST STRAP

The Life Fitness stairclimber is equipped with Polar telemetry, a heart rate monitoring system in which electrodes, pressed against the skin, transfer heart rate signals to the console. These electrodes are attached to a chest strap that the user wears during the workout. The chest strap is optional. To order it, call Life Fitness Customer Support Services. See Section 6.5, titled *How to Obtain Product Service*.

See the diagram below for correct positioning of the strap. The electrodes (A), which are the two grooved surfaces on the underside of the strap, must remain wet to transmit accurately the electrical impulses of the heart back to the receiver. Moisten the electrodes. Then, secure the strap as high under the chest muscles as possible. The strap should be snug, but comfortable enough to allow for normal breathing.

The transmitter strap delivers an optimal heart rate reading when the electrodes are in direct contact with skin. However, it also functions properly through a thin layer of wet clothing.

If it becomes necessary to re-moisten the chest strap electrodes, grasp the center of the strap, pull it away from the chest to expose the two electrodes, and moisten them.

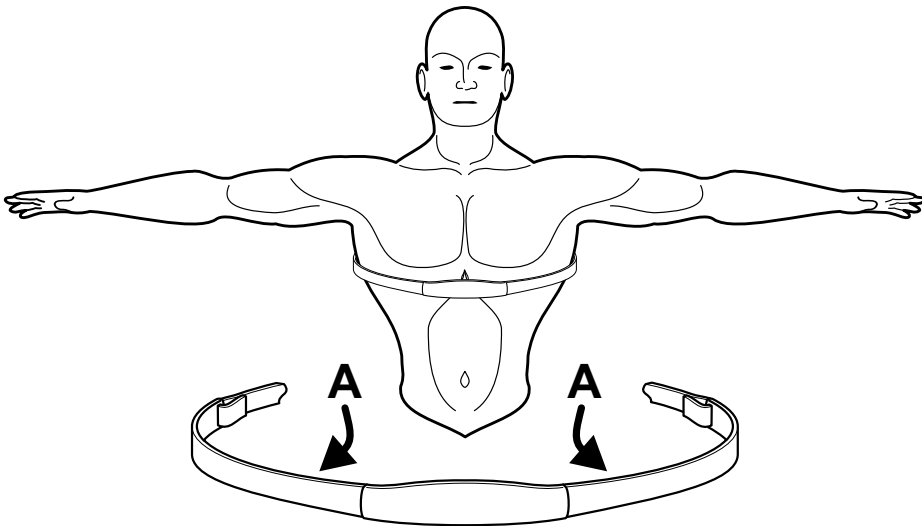

4 THE WORKOUTS

4.1 WORKOUT OVERVIEWS

This section lists the Life Fitness stairclimber pre-programmed workouts. For more detailed information, see Section 4.2, titled *Using the Workouts*.

QUICK START is the fastest way to begin exercising, and it bypasses the steps involved in selecting a specific workout. Once **QUICK START** is selected, a constant-level workout begins. The intensity level does not change automatically.

FAT BURN is a lower-intensity workout for burning the body's fat reserves. The user must grasp the Lifepulse system sensors continuously or wear a heart rate chest strap. The workout automatically adjusts the intensity level, based on the actual heart rate, to maintain the rate at 65 percent of the theoretical maximum[†].

CARDIO is a higher intensity workout for more fit users, emphasizing cardiovascular benefits and maximum fat burning. The user must grasp the Lifepulse system sensors continuously or wear a heart rate chest strap. The workout automatically adjusts the intensity level, based on the actual heart rate, to maintain the rate at 80 percent of the theoretical maximum.

RANDOM is an interval training workout of constantly changing intensity levels that occur in no regular pattern or progression to challenge the user.

MANUAL is a workout in which the intensity level does not change automatically.

The following three workouts are accessed by pressing the ZONE TRAINING+ key :

HEART RATE HILL consists of three hills that target three heart rate goals: The first hill brings the heart rate to 90 percent of the target rate*. The second hill increases the rate to 95 percent. The third hill matches the target heart rate. The valley always is defined as 85 percent of the target. The user must grasp the Lifepulse system sensors continuously or wear a heart rate chest strap.

HEART RATE INTERVAL alternates between a hill, which brings the heart rate up to the target rate, and a valley, which brings the heart rate down to 90 percent of the target. The user must grasp the Lifepulse system sensors continuously or wear a heart rate chest strap.

EXTREME HEART RATE alternates between two target heart rate goals as quickly as possible. The effect is similar to that of running sprints. The user must grasp the Lifepulse system sensors continuously or wear a heart rate chest strap.

The following seven workouts are accessed by pressing the HILL PLUS key :

HILL is an interval-training workout combining "hills" and "valleys" of different intensity levels, which is proven to provide effective, time-efficient cardiovascular results.

[†] Defined by the American College of Sports Medicine's "Guidelines for Exercise Testing and Prescription" as equal to 220 minus an individual's age.

* Target Heart Rate (THR) is a percentage of the theoretical maximum. For example, a 40-year-old user's THR for the **HEART RATE HILL** workout is 144. This workout targets 80 percent of the maximum, so the equation would be $(220-40) \cdot 80 = 144$. A 20-year-old user's THR is 160, so the equation would be $(220-20) \cdot 80 = 160$.

AROUND THE WORLD is an interval-training workout in which the hills resemble scenes of various geographical areas.

KILIMANJARO is a Hill workout in which the intensity levels gradually incline toward one ultimate peak and then gradually decline.

INTERVAL is a Hill workout in which intensity levels rise and fall. The higher levels gradually incline toward a peak and then gradually decline.

CASCADES is a two-peak workout in which intensity levels gradually incline and decline.

SPEED TRAINING is a Hill workout in which the intensity level alternates between high and low levels very quickly to simulate a typical speed training workout.

FOOT HILLS is a rolling hill workout with low intensity levels.

The following workouts are accessed by pressing the PERSONAL TRAINER key :

WATTS (if enabled) targets a rate of effort equal to a certain number of Watts. A Watt is a unit of power that measures the amount of mechanical work required to operate a device, such as a Life Fitness stairclimber. It is roughly equal to .25 calories per hour.

METS (if enabled) targets a rate of effort equal to a certain number of Mets. A Met is a unit of measurement used to express the metabolic rate of work (oxygen consumption per unit of body weight) required to perform a task. One Met is approximately equal to a person's metabolism when seated and relaxed.

PERSONAL TRAINER WORKOUTS are custom interval or heart rate workouts that may be created by personal trainers or other authorized fitness club staff members. Up to six different workouts may be programmed and stored in the computer. For more information, see section 4.4, titled *Personal Trainer Workouts*.

4.2 USING THE WORKOUTS

Different workouts require different setup steps. See the chart on the facing page, titled *Life Fitness Stairclimber Workout Set-up Steps* for a quick glance at the steps for setting up any workout. This section provides details on the steps themselves.

Note: *A new Life Fitness stairclimber may emit a slight smell during the first few hours of operation as the load resistor heats up for the first time. If the smell persists, contact customer service.*

TO BEGIN ANY WORKOUT

Without networking, press START or simply step on the pedals to activate the console. The MESSAGE CENTER displays the prompt: "SELECT WORKOUT OR PRESS QUICK START". If it displays a different message, press the CLEAR key twice rapidly.

When the stairclimber is networked, press START or step on the pedals to activate the console. The MESSAGE CENTER displays the prompt: "SELECT WORKOUT OR ENTER ID USING ENTER KEY". Select a workout, or log on to the networked exercise database, download the preset workout. To log onto the network, key in the user ID number with the NUMERIC KEYPAD.

SELECTING QUICK START

QUICK START is the fastest way to begin exercising, and it bypasses the steps of selecting a specific workout. At the MESSAGE CENTER prompt, press the QUICK START key. The workout begins at an intensity level that remains the same unless manually changed.

SELECTING A WORKOUT

For **MANUAL**, **FAT BURN**, **CARDIO**, and **RANDOM**: When prompted to select a workout, press the key labeled with the name of the desired workout.

For **HEART RATE HILL**, **HEART RATE INTERVAL**, and **EXTREME HEART RATE**: When prompted by the MESSAGE CENTER to select a workout, press the ZONE TRAINING+ key. The MESSAGE CENTER then displays the name of the one of the three workouts. Press ENTER to select the displayed workout; or continue to press the ZONE TRAINING+ key to display each of the other three options, and then press ENTER to select the desired workout.

For **WATTS**, **METS**, and **PERSONAL TRAINER WORKOUTS**: When prompted by the MESSAGE CENTER to select a workout, press the PERSONAL TRAINER key. The MESSAGE CENTER then displays the name of one of the workouts. Press ENTER to select the displayed workout; or continue to press the PERSONAL TRAINER key to display each of the other options. Press ENTER to select the desired workout. For **PERSONAL TRAINER WORKOUTS**, once a workout is configured and saved, no further setup steps are necessary. For more information, see section 4.4, titled *Personal Trainer Workouts*.

For **HILL**, **AROUND THE WORLD**, **KILIMANJARO**, **INTERVAL**, **CASCADES**, **SPEED TRAINING**, and **FOOT HILLS**: When prompted by the MESSAGE CENTER to select a workout, press the HILL PLUS key. The MESSAGE CENTER then displays the name of the one of these workouts. Press ENTER to select the displayed workout; or continue to press the HILL PLUS key to display each of the other six options, and then press ENTER to select the desired workout.

ENTERING WEIGHT

When prompted by the MESSAGE CENTER to enter weight, use the ARROW KEYS to increase or decrease the displayed weight to the correct value, or key in the correct value with the NUMERIC KEYPAD, and press ENTER. Stairclimber workouts calculate the number of calories burned based on the user's weight and step rate.

ENTERING AGE

When prompted by the MESSAGE CENTER to enter age, use the ARROW KEYS to increase or decrease the displayed age to the correct value, or key in the correct value with the NUMERIC KEYPAD, and press ENTER. Stairclimber workouts that set a target heart rate* zone first calculate the user's theoretical maximum heart rate† by subtracting the user's age from the number 220. The workouts then calculate the target zone as a percentage of the theoretical maximum.

ENTERING TIME

When prompted by the MESSAGE CENTER to enter a time, use the ARROW KEYS to increase or decrease the displayed time to the desired value, or key in the desired value with the NUMERIC KEYPAD, and press ENTER.

† Defined by the American College of Sports Medicine's "Guidelines for Exercise Testing and Prescription" as equal to 220 minus an individual's age.

* Target Heart Rate (THR) is a percentage of the theoretical maximum. For example, a 40-year-old user's THR for the **HEART RATE HILL** workout is 144. This workout targets 80 percent of the maximum, so the equation would be $(220-40) \cdot 80 = 144$. A 20-year-old user's THR is 160, so the equation would be $(220-20) \cdot 80 = 160$.

SELECTING AND ADJUSTING THE INTENSITY LEVEL

When prompted by the MESSAGE CENTER, use the ARROW keys to increase or decrease the displayed intensity level or target heart rate* to the desired value, or key in the desired value with the NUMERIC KEYPAD, and press ENTER. Adjust the level as needed or desired during the workout.

- Intensity level: The Life Fitness stairclimber provides a selection of 20 intensity levels. The step speed for Level 1, the easiest setting, is two floors per minute; the tiers of difficulty increase up to Level 20, with a step rate of 13 floors per minute. The intensity level appears in the WORKOUT PROFILE window as columns of light. Selecting a low intensity level at first is recommended. As physical conditioning improves, the levels can increase.
- Target heart rate: Stairclimber workouts that calculate a target heart rate base this number on the age of the user and the type of workout. The user accepts or adjusts the rate when setting up the workout. During the workout itself, the workout reads the heart rate, which is transmitted via the Lifepulse system Sensors or the chest strap; and it uses this data to adjust the resistance. Manually raising the rate increases the intensity of the cardiovascular exercise.

SELECTING A GOAL TYPE

Workouts can be programmed to target certain type of goals other than the default time goal:

- Calories
- Distance
- Time in zone

The **Calories Goal** feature is designed to promote weight loss and weight control. The user sets a calorie goal during the workout setup. Once the goal is met, the workout automatically goes into a cool-down phase and ends afterward. To use this feature:

1. Press the the PERSONAL TRAINER key when prompted to select a workout.
2. Continue to press the PERSONAL TRAINER key until the MESSAGE CENTER displays "CALORIES GOAL".
3. Press ENTER.
4. Enter the desired calorie goal value.
5. Select any workout, except for **AROUND THE WORLD, KILIMANJARO, INTERVAL, CASCADES, SPEED TRAINING, or FOOT HILLS.**
6. Run through the set-up steps for the selected workout.
7. Begin the workout.

* Target Heart Rate (THR) is a percentage of the theoretical maximum. For example, a 40-year-old user's THR for the **HEART RATE HILL** workout is 144. This workout targets 80 percent of the maximum, so the equation would be $(220-40) \cdot 80 = 144$. A 20-year-old user's THR is 160, so the equation would be $(220-20) \cdot 80 = 160$.

The **Distance Goal** feature is designed to build endurance. The user sets a distance goal during the workout setup. Once the goal is met, the workout automatically goes into a cool-down phase and ends afterward. To use this feature:

1. Press the the PERSONAL TRAINER key when prompted to select a workout.
2. Continue to press the PERSONAL TRAINER key until the MESSAGE CENTER displays “DISTANCE GOAL”.
3. Press ENTER.
4. Enter the desired distance goal value.
5. Select any workout, except for **AROUND THE WORLD, KILIMANJARO, INTERVAL, CASCADES, SPEED TRAINING, or FOOT HILLS.**
6. Run through the set-up steps for the selected workout.
7. Begin the workout.

The **Time in Zone Goal** option enhances **FAT BURN CARDIO, HEART RATE HILL, HEART RATE INTERVAL,** and **EXTREME HEART RATE** workouts by setting a certain duration within the target zone* as a workout goal. The program automatically alters the resistance to maintain a pace that will meet that objective within that duration. Once the objective is met, the workout automatically goes into a cool-down phase. To use the Time In Zone Goal feature:

1. Press the ZONE TRAINING+ key when prompted to select a workout
2. Continue to press the ZONE TRAINING+ key until the MESSAGE CENTER displays “TIME IN ZONE GOAL”.
3. Press ENTER.
4. Select the duration for staying within the zone.
5. Select a **FAT BURN, CARDIO, HEART RATE HILL, HEART RATE INTERVAL,** or **EXTREME HEART RATE** workout.
6. Enter age.
7. Accept or change the target heart rate* displayed by the MESSAGE CENTER.
8. Begin the workout.

SWITCHING WORKOUTS “ON-THE-FLY”

It is possible, during a workout, to switch to another workout. After a switch, the console retains all the progress information about the workout since its beginning. To change workouts “on the fly,” simply press the key for the desired new workout.

PAUSING WORKOUTS

To pause a workout, simply stop climbing. To continue the workout, resume climbing. The pause duration lasts 60 seconds. During that time, it is possible to step off and back on without stopping the workout. If the workout is not resumed in 60 seconds, the console automatically shuts down.

* Target Heart Rate (THR) is a percentage of the theoretical maximum. For example, a 40-year-old user's THR for the **HEART RATE HILL** workout is 144. This workout targets 80 percent of the maximum, so the equation would be $(220-40) \cdot .80 = 144$. A 20-year-old user's THR is 160, so the equation would be $(220-20) \cdot .80 = 160$.

ENDING WORKOUTS EARLY

To end a workout before the pre-set duration expires, press CLEAR once. The MESSAGE CENTER then displays a workout summary, which includes the number of floors climbed, the total calories burned, and other statistics. Press CLEAR a second time, and the MESSAGE CENTER displays "SELECT WORKOUT OR PRESS QUICK START" for a new workout.

LIFE FITNESS STAIRCLIMBER WORKOUT SETUP STEPS

QUICK START

Press Quick Start
Begin workout
Enter weight

RANDOM

Press Random
Enter weight
Enter time
Select intensity level
Begin workout

MANUAL

Press Manual
Enter weight
Enter time
Select intensity level
Begin workout

HILL

Press HILL PLUS
repeatedly until HILL
appears; press
ENTER
Enter weight
Enter time
Select intensity level
Begin workout

FAT BURN*

Press FAT BURN
Enter weight
Enter time
Enter age
Accept THR**
Begin workout

CARDIO*

Press CARDIO
Enter weight
Enter time
Enter age
Accept THR**
Begin workout

HEART RATE HILL*

Press ZONE
TRAINING+ repeat-
edly until HEART
RATE HILL appears;
press ENTER
Enter weight
Enter time
Enter age
Accept THR**
Begin workout

HEART RATE INTERVAL*

Press ZONE
TRAINING+ repeat-
edly until HEART
RATE INTERVAL
appears; press
ENTER
Enter weight
Enter time
Enter age
Accept THR**
Begin workout

EXTREME HEART RATE*

Press ZONE
TRAINING+ repeat-
edly until EXTREME
HEART RATE
appears; press
ENTER
Enter weight
Enter time
Enter age
Accept THR**
Begin workout

WATTS (if enabled)

Press PERSONAL
TRAINER repeatedly
until WATTS appears;
press ENTER
Enter weight
Enter time
Enter Watts goal value
Begin workout

METS (if enabled)

Press PERSONAL
TRAINER repeatedly
until METS appears;
press ENTER
Enter weight
Enter time
Enter Mets goal value
Begin workout

AROUND THE WORLD

Press HILL PLUS
repeatedly until
AROUND THE
WORLD appears;
press ENTER
Enter weight
Enter time
Select intensity level
Begin workout

KILIMANJARO

Press HILL PLUS
repeatedly until KILI-
MANJARO appears;
press ENTER
Enter weight
Enter weight
Enter time
Select intensity level
Begin workout

INTERVAL

Press HILL PLUS
repeatedly until
INTERVAL appears;
press ENTER
Enter weight
Enter weight
Enter time
Select intensity level
Begin workout

CASCADES

Press HILL PLUS
repeatedly until CAS-
CADES appears;
press ENTER
Enter weight
Enter weight
Enter time
Select intensity level
Begin workout

SPEED TRAINING

Press HILL PLUS
repeatedly until
SPEED TRAINING
appears; press
ENTER
Enter weight
Enter time
Select intensity level
Begin workout

FOOT HILLS

Press HILL PLUS
repeatedly until
FOOT HILLS
appears; press
ENTER
Enter weight
Enter weight
Enter time
Select intensity level
Begin workout

PERSONAL TRAINER WORKOUTS

Press PERSONAL
TRAINER repeatedly
until "PERSONAL
TRAINER" appears;
press ENTER
Select PERSONAL
TRAINER workout
number from 1 to 6;
press ENTER
Begin workout

* This workout requires the user to wear the telemetry chest strap or to grip the Lifepulse sensors throughout the workout.

** Target Heart Rate (THR) is a percentage of the theoretical maximum. For example, a 40-year-old user's THR for the HEART RATE HILL workout is 144. This workout targets 80 percent of the maximum, so the equation would be $(220-40) \cdot 80 = 144$. A 20-year-old user's THR is 160, so the equation would be $(220-20) \cdot 80 = 160$.

4.3 WORKOUT DESCRIPTIONS

QUICK START

QUICK START is the fastest way to begin exercising, and it bypasses the steps of selecting a specific workout. The intensity level for the workout is set automatically and remains the same unless manually changed. To change the level, press the UP or DOWN ARROW keys or use the NUMERIC keypad to enter a higher or lower level number. If the CALORIES PER HOUR display is enabled, the MESSAGE CENTER displays ENTER WEIGHT, which is required to calculate this value. Using the ARROW KEYS, increase or decrease the displayed weight to the correct value, or enter the weight using the NUMERIC KEYPAD.

FAT BURN

The **FAT BURN** workout is designed to maintain a user's heart rate at 65 percent of the theoretical maximum[†] for optimal results. Throughout the workout, the user grasps the Lifepulse system sensors or wears a chest strap. If the user is not wearing a chest strap, the WORKOUT PROFILE window displays a heart shape, and the MESSAGE CENTER displays a prompt to grasp the sensors. The console continuously monitors and displays the heart rate, adjusting the intensity level of the Life Fitness stairclimber to reach and maintain the target*. This system eliminates over- and under-training, and it maximizes the aerobic benefits of exercise by using the body's fat stores for fuel.

CARDIO

The **CARDIO** workout is virtually identical to **FAT BURN**; however the target heart rate is calculated at 80 percent of the theoretical maximum. The user grasps the Lifepulse system sensors or wears a chest strap throughout the **CARDIO** workout. The higher target promotes cardiovascular improvement by placing a heavier workload on the heart muscle.

HILL

The Life Fitness-patented **HILL** workout offers a variety of configurations for interval training. Intervals are periods of intense aerobic exercise separated by regular periods of lower-intensity exercise. The WORKOUT PROFILE window represents these high and low intervals as columns of light, which together have the appearance of hills and valleys.

The computerized interval training workout has been scientifically demonstrated to promote greater cardio-respiratory improvement than steady-pace training.

Each **HILL** workout goes through four phases, each marked by different intensity levels. The WORKOUT PROFILE window displays the progress of these phases, as seen in the chart following these descriptions below. As noted in the descriptions, the heart rate should be measured at two stages in the workout to gauge its effectiveness. To do so, continuously grasp the Lifepulse system sensors, or wear the chest strap. Note that the MESSAGE CENTER does not display a request for a heart rate measurement during a **HILL** workout.

1 Warm-up is a phase of low, gradually rising resistance, which brings the heart rate into the lower end of the target* zone and increases respiration and blood flow to working muscles.

[†] Defined by the American College of Sports Medicine's "Guidelines for Exercise Testing and Prescription" as equal to 220 minus an individual's age.

* Target Heart Rate (THR) is a percentage of the theoretical maximum. For example, a 40-year-old user's THR for the **FAT BURN** workout is 117. This workout targets 65 percent of the maximum, so the equation would be $(220-40) \times .65 = 117$. A 20-year-old user's THR is 130, so the equation would be $(220-20) \times .65 = 130$.

- 2 **Plateau** increases the intensity slightly, and keeps it steady, to bring the heart rate to the low end of the target zone. Check the heart rate at the end of this phase.
- 3 **Interval Training** is a series of increasingly steeper hills, alternating with valleys, or stints of recovery. The heart rate should rise to the high end of the target zone. Check the heart rate at the end of this phase.
- 4 **Cool-down** is a low-intensity phase that allows the body to begin removing lactic acid, and other exercise by-products, which build up in muscles and contribute to soreness.

TERRAIN (HILLS AND VALLEYS)

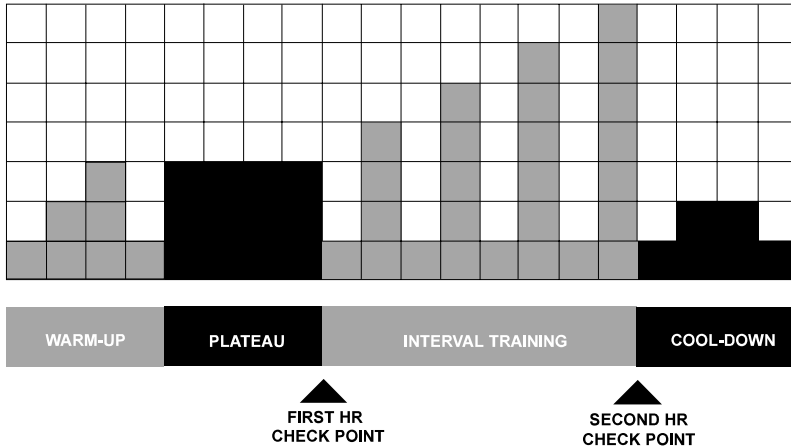

Each column, as seen in the WORKOUT PROFILE WINDOW and the chart above, represents one interval. The overall duration of the workout determines the length of each interval. Each workout is made up of 20 intervals, so the duration of each interval is equal to the duration of the entire workout divided by 20.

10 to 19 minutes: The interval durations initially are set at 30 seconds for a 10-minute workout. For every minute added by the user “on the fly,” each interval increases by three seconds. A 15-minute workout consists of 20 intervals at 45 seconds each.

20 to 99 minutes: All intervals last 60 seconds. If the user adds minutes to the pre-set duration while the workout is in progress, the workout adds hills and valleys that are identical to the first eight intervals of the Interval Training phase. This pattern repeats until the workout is completed.

RANDOM

The **RANDOM** workout creates a terrain of hills and valleys that varies with each workout. More than one million different patterns are possible.

MANUAL

The **MANUAL** workout sets an intensity level that does not change automatically. While the workout is in progress, increase or lower the intensity level as desired, using the LEVEL ARROW keys or the NUMERIC keypad.

HEART RATE HILL™ WORKOUT

This workout consists of three hills that target three heart rate goals: The first hill brings the heart rate to 90 percent of the target rate*. The second hill increases the rate to 95 percent. The third hill matches the target heart rate. The valley always is defined as 85 percent of the target. After a warm-up, the workout progresses toward the first hill and heart rate goal. Once the user reaches 90 percent of the target heart rate, the hill continues for one minute. When the minute expires, the level decreases into a valley. Once the user's heart rate falls to 85 percent of the target, the valley continues for one minute. Then, the next hill begins with its corresponding heart rate goal. After the user completes the third hill/valley pair, the workout returns to the first hill and repeats the cycle as long as the duration allows. See the chart below. The user must continuously grasp the Lifepulse system sensors or wear a Polar heart rate chest strap to enable the computer to monitor the heart rate.

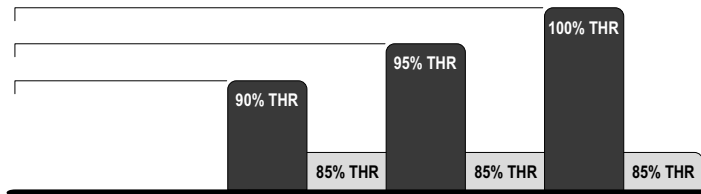

HEART RATE HILL Workout Profile

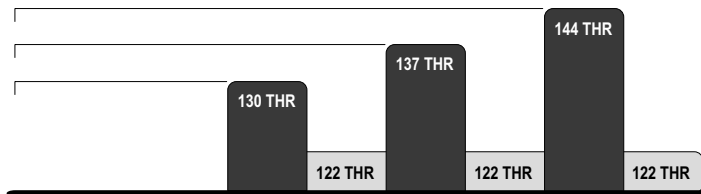

User Example 80 percent of theoretical maximum (40 year old / 144 recommended THR)

* Target Heart Rate (THR) is a percentage of the theoretical maximum. For example, a 40-year-old user's THR for the **HEART RATE HILL** workout is 144. This workout targets 80 percent of the maximum, so the equation would be $(220-40) \cdot 80 = 144$. A 20-year-old user's THR is 160, so the equation would be $(220-20) \cdot 80 = 160$.

HEART RATE INTERVAL™ WORKOUT

This workout alternates between a hill, which brings the heart rate up to the target rate*, and a valley, which brings the heart rate down to 90 percent of the target. After a warm-up, the workout progresses toward the first hill and heart rate goal. Once the goal is reached, the hill continues for three minutes. Then the level decreases into a valley. Once the 90 percent goal is reached, the valley continues for three minutes, after which the next hill begins. The user's fitness level determines the number of hills and valleys encountered within the duration. See the chart below. The user must continuously grasp the Lifepulse system sensors or wear a Polar heart rate chest strap to enable the computer to monitor the heart rate.

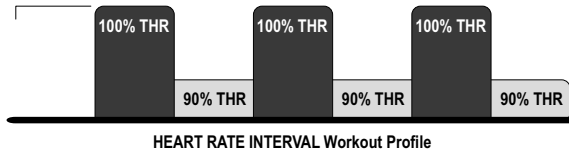

User Example 80 percent of theoretical maximum (40 year old / 144 recommended THR)

EXTREME HEART RATE™ WORKOUT

This intense, varied workout is designed to help more experienced users to break through fitness improvement plateaus. The workout alternates between two target heart rate goals as quickly as possible. The effect is similar to that of running sprints. When setting up the workout, the user enters a target heart rate. After a warm-up, the intensity gradually increases until the user reaches the 100 percent target heart rate goal. Then, that target rate is maintained for a stabilizing period. Afterward, the intensity decreases. When the heart rate falls to the 75 percent goal, it is maintained there for a stabilizing period. The program repeats the alternating of intensity levels, continuing this pattern for the duration. See the chart below. The user must continuously grasp the Lifepulse system sensors or wear a Polar heart rate chest strap to enable the computer to monitor the heart rate.

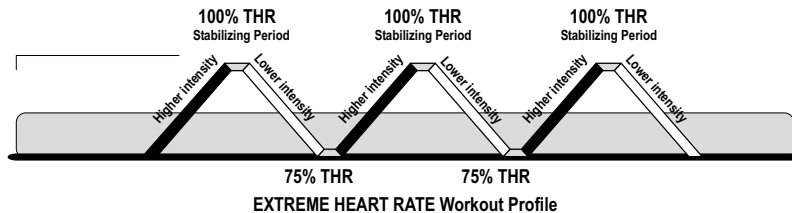

User Example (40 year old / 153 recommended THR)

* Target Heart Rate (THR) is a percentage of the theoretical maximum. For example, a 40-year-old user's THR for the HEART RATE INTERVAL workout is 144. This workout targets 80 percent of the maximum, so the equation would be $(220-40) \cdot 80=144$. A 20-year-old user's THR is 160, so the equation would be $(220-20) \cdot 80=160$.

WATTS (IF ENABLED)

This workout targets a rate of effort equal to a certain number of Watts. A Watt is a unit of power that measures the amount of mechanical work required to operate a device, such as a Life Fitness stairclimber. It is roughly equal to 0.25 calories per hour. The workout automatically alters the intensity level to maintain the appropriate rate of effort.

METS (IF ENABLED)

This workout targets a rate of effort equal to a certain number of Mets. A Met is a unit of measurement used to express the metabolic rate of work (oxygen consumption per unit of body weight) required to perform a task. The workout automatically alters the intensity level to maintain the appropriate rate of effort.

SIX PRE-SET WORKOUTS

AROUND THE WORLD, KILIMANJARO, INTERVAL, CASCADES, SPEED TRAINING, and FOOTHILLS are variations of the **HILL** workout. These workouts cannot be changed "on the fly."

AROUND THE WORLD is an interval-training workout in which the hills resemble scenes of various geographical areas.

KILIMANJARO is a Hill workout in which the intensity levels gradually incline toward one ultimate peak and then gradually decline.

INTERVAL is a Hill workout in which intensity levels rise and fall. The higher levels gradually incline toward a peak and then gradually decline.

CASCADES is a two-peak workout in which intensity levels gradually incline and decline.

SPEED TRAINING is a Hill workout in which the intensity level alternates between high and low levels very quickly to simulate a typical speed training workout.

FOOT HILLS is a rolling hill workout with low intensity levels.

4.4 PERSONAL TRAINER WORKOUTS

Custom interval heart rate and hill workouts may be created by fitness club managers or other authorized personnel.

- **Interval heart rate:** The trainer can design a workout that sets a different target heart rate for each interval and adjusts the step speed to the user's heart rate.
- **Hill:** The trainer can create a custom hill workout that sets a different intensity level for each interval.

USING PERSONAL TRAINER WORKOUTS

Once custom workouts are created, users can access them with the **PERSONAL TRAINER** key. Each custom workout is identified by a numeral, from 1 to 6. To select one, press the **PERSONAL TRAINER** key. When prompted by the **MESSAGE CENTER**, press the number corresponding to the desired workout, using the **NUMERIC** keypad. Then, press **ENTER** and begin the workout.

CREATING A PERSONAL TRAINER WORKOUT

When the console is activated, hold down the **COOL DOWN** button, and press the **PERSONAL TRAINER** button simultaneously. Select a number, from 1 to 6, to identify the new workout. Use the **NUMERIC** keypad or the **ARROWS**. Then, press **ENTER**.

If a custom workout already has been created for that number, the MESSAGE CENTER displays a prompt to either modify the workout or proceed to another number. Pressing the CLEAR key overwrites the previously created workout, making it possible to create a new workout for that number. Pressing ENTER bypasses the number and proceeds to another number. If a custom workout has not been created for a selected number, the MESSAGE CENTER displays the prompt, "BEGIN PERSONAL WORKOUT CREATION."

The MESSAGE CENTER displays a prompt to enter a duration time for the entire workout. Using the NUMERIC keypad, enter a duration and press ENTER. The workout cannot exceed the maximum time duration, which is defined in the Optional Settings. See Section 5.1 for more information. The MESSAGE CENTER displays a prompt to select the workout type. Options are TARGET HEART RATE PERCENTAGE or LEVEL. The latter type is for custom hill workouts. Use the ARROW keys to toggle between the options, and press ENTER to select one of them.

The MESSAGE CENTER displays a prompt to select a target heart rate or an intensity level for the first interval, depending on the type of workout chosen in an earlier step. Use the ARROW keys or the NUMERIC keypad. A custom workout consists of 30 intervals, so the length of each interval is equal to the workout duration value divided by 30. After entering the value, press ENTER. Repeat this set of steps for each of the following 29 intervals. To keep the preceding value for the current interval, simply press ENTER.

At the end of this setup, the MESSAGE CENTER displays "PERSONAL WORKOUT COMPLETED". Afterward, the MESSAGE CENTER displays "SELECT WORKOUT OR PRESS QUICK START". The new custom workout is ready to use.

4.5 USING THE LIFE FITNESS STAIRCLIMBER

STAIRCLIMBER MOTION

The Life Fitness stairclimber permits a maximum stepping height of 13.5 inches, or 34.3 centimeters. The unit features independent stepping action, which means that the pedals move independently of each other. Benefits of this feature include:

- Pull-push hip and knee action, which simulates actual stair climbing
- Development of greater muscular strength and endurance
- Optimal muscular development for the right leg and left leg individually
- Better cardiovascular exercise

POSTURE DURING WORKOUTS

Begin stepping at a comfortable pace, taking either full or short steps, and keeping the back straight. Hold the handrails or the bullhorns for stability and balance only. It should be noted that using the handrails for support can offload weight and cause the Life Fitness stairclimber console to give inaccurate readings of calories burned.

BRAKING RESISTANCE

The Life Fitness stairclimber features speed-dependent braking resistance. During a workout, the computer monitors the user's step rate and maintains it at the rate that corresponds to the selected intensity level. If the user's speed exceeds the corresponding rate, the computer increases the resistance to lower the user's speed. If the user's step rate is slower, the computer decreases the resistance to enable the user to increase speed.

5 OPTIONAL SETTINGS

5.1 ENTERING AND USING THE OPTIONAL SETTINGS FEATURE

Fitness club managers and other authorized personnel can use the Optional Settings feature to change default settings, or to enable or disable certain programs or displays on the console.

To enter the Optional Settings, while the unit is on, hold down the “5” key on the NUMERIC keypad and press CLEAR twice. The MESSAGE CENTER displays a program version number. Press the ENTER key. The MESSAGE CENTER displays “OPTIONAL SETTINGS”. Scroll forward through the options using the ENTER key, or backward, using the CLEAR key. For each feature or setting option, the MESSAGE CENTER displays the default setting. To change the default, press the UP or DOWN ARROW key for the desired value, or use the NUMERIC keypad. Press ENTER to select the new value or setting and proceed to the next setting.

To exit Optional Settings, press the CLEAR key repeatedly until the MESSAGE CENTER displays SELECT WORKOUT OR PRESS QUICK START. Or, after the last setting has been displayed and it is impossible to scroll forward by pressing ENTER, hold down the QUICK START key, and press CLEAR. The MESSAGE CENTER then displays the prompt to select a workout.

OPTIONAL SETTINGS		
Setting	Default Value	Description
MAX WORKOUT DURATION	60 minutes	This is the maximum possible duration for a workout. The value can range from 1 to 99.
ENGLISH/METRIC UNITS	ENGLISH	This option determines the units of weight measurement used by workouts.
WATTS DISPLAY ENABLE/ DISABLE	DISABLED	If this option is enabled, the MESSAGE CENTER displays the Watts equivalent of the step rate.
METS DISPLAY ENABLE/ DISABLE	DISABLED	If this option is enabled, the MESSAGE CENTER displays the Mets equivalent of the step rate.
CAL/HR DISPLAY ENABLE/ DISABLE	DISABLED	If this option is enabled, the MESSAGE CENTER displays the number of calories burned per hour during the workout.
WATTS PROGRAM ENABLE/ DISABLE	DISABLED	If this option is enabled, the Watts workout becomes an available workout on the Life Fitness stairclimber.
METS PROGRAM ENABLE/ DISABLE	DISABLED	If this option is enabled, the Mets workout becomes an available workout on the Life Fitness stairclimber.

6 SERVICE AND TECHNICAL DATA

6.1 PREVENTATIVE MAINTENANCE TIPS

The Life Fitness stairclimber is backed by the engineering excellence of Life Fitness and is one of the most rugged and trouble-free pieces of exercise equipment on the market today. Commercial Life Fitness products have proven to be durable in health clubs, colleges, military facilities, and other locations the world over. This same technology, engineering expertise, and reliability have gone into the Life Fitness stairclimber.

NOTE: *The safety of the equipment can be maintained only if the equipment is examined regularly for damage or wear. Keep the equipment out of use until defective parts are repaired or replaced. Pay special attention to parts that are subject to wear as outlined in the Preventive Maintenance Schedule. See Section 6.1.*

REMARQUE : *pour conserver un matériel sûr, il convient de l'inspecter régulièrement afin de détecter tout signe d'usure ou d'endommagement. N'utilisez pas l'appareil tant que les pièces défectueuses n'ont pas été réparées ou remplacées. Portez une attention toute particulière aux pièces qui s'usent, comme indiqué ci-dessous.*

The following preventive maintenance tips will keep the Life Fitness stairclimber operating at peak performance:

- Locate the Life Fitness stairclimber in a cool, dry place.
- Clean the top surface of the pedals regularly.
- Keep the display console free of fingerprints and salt build-up caused by sweat.
- Use a **100% cotton cloth**, lightly moistened with water and mild liquid cleaning product, to clean the Life Fitness stairclimber. Other fabrics, including paper towels, may scratch the surface. **Do not use ammonia or acid-based cleaners.**
- Long fingernails may damage or scratch the surface of the console; use the pad of the finger to press the selection buttons on the console.
- Clean the housing thoroughly on a regular basis.

NOTE: *A non-abrasive cleaner and soft cotton cloth are strongly recommended for cleaning the exterior of the unit. At no time should cleaner be applied directly to any part of the equipment; apply the non-abrasive cleaner on a soft cloth, and then wipe the unit.*

6.2 INSPECTING AND CLEANING THE STAIRCLIMBER

Follow the schedule below to ensure proper operation of the product.

ITEM	WEEKLY	MONTHLY	BI-ANNUALLY	ANNUALLY
<i>Display Console</i>	C	I		
<i>Console Mounting Bolts</i>			I	
<i>Accessory Tray</i>	C	I		
<i>Frame</i>	C			I
<i>Plastic Covers</i>	C	I		

KEY: C=Clean; I=Inspect

6.3 TROUBLESHOOTING THE LIFEPULSE SYSTEM SENSORS

If the heart rate reading is erratic or missing, check the following:

- Dry moist hands to prevent slipping.
- Apply hands to all four sensors, two in each hand.
- Grasp the sensors firmly.
- Apply constant pressure around the sensors.
- Clean the sensors with a damp cloth.

6.4 TROUBLESHOOTING THE POLAR HEART RATE CHEST STRAP

HEART RATE READING IS ERRATIC OR ABSENT ENTIRELY

- Repeat the electrode moistening procedure. See Section 3.2, titled *Heart Rate Monitoring* for details. The electrodes must remain wet to pick up and transmit “accurate heart rate readings.
- Make sure the electrodes are flat against the skin.
- Wash the belt transmitter regularly with mild soap and water.
- Make sure the chest strap transmitter is within three feet (91 centimeters) of the heart rate receiver.
- The chest strap is battery-operated and will stop functioning when the battery runs out. Contact Life Fitness Customer Support Services for instructions on how to have the chest strap replaced. See section 6.4, titled *How to Obtain Product Service*.

HEART RATE READING IS ERRATIC OR EXTREMELY HIGH

If the chest strap is worn near sources of electromagnetic signals, these signals may be strong enough to elevate heart rate readings. Possible sources include:

- Television sets and/or antennas, cell phones, computers, cars, high voltage power lines and motor driven exercise equipment.
- Another heart rate transmitter within three feet, or one meter, may also cause abnormal heart rate readings.

6.5 HOW TO OBTAIN PRODUCT SERVICE

1. Verify the symptom and review the operating instructions. The problem may be unfamiliarity with the product and its features and workouts.
2. Locate and document the serial number of the unit. This number consists of three letters followed by six numbers. The serial number plate is located at the back end of the unit.

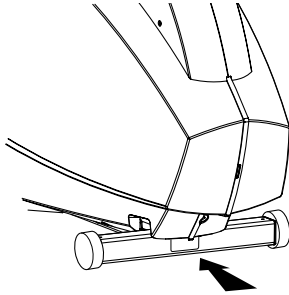

3. Contact Life Fitness Customer Support Services via the Web at: www.lifefitness.com, or call the nearest Life Fitness Customer Support Services group:

For Product Service within
the United States and Canada:

Telephone: (+1) 847.451.0036
FAX: (+1) 847.288.3702
Toll-free telephone: 800.351.3737

For Product Service Internationally:

Life Fitness Europe GmbH
Telephone: (+49) 089.317.751.66
FAX: (+49) 089.317.751.38

Life Fitness (UK) LTD
Telephone: (+44) 1353.665507
FAX: (+44) 1353.666018

Life Fitness Atlantic BV

Life Fitness Benelux
Telephone: (+32) 03.644.44.88
FAX: (+32) 03.644.24.80
Telephone: (+32) 87.300.942
FAX: (+32) 87.300.943

Life Fitness Italia S.R.L.
Telephone: (+39) 0472.835.470
FAX: (+39) 0472.833.150
Toll-free telephone: 800.438836

Life Fitness Vertriebs GmbH
Telephone: (+43) 1615.7198
FAX: (+43) 1615.7198.20

Life Fitness Asia Pacific Ltd
Telephone: (+852) 2891.6677
FAX: (+852) 2575.6001

*Life Fitness Latin America
and Caribbean*
Telephone: (+1) 847.288.3964
FAX: (+1) 847.288.3886

Life Fitness Brazil
Telephone: (+55) 11.7295.2217
FAX: (+55) 11.7295.2218

Life Fitness Japan
Telephone: (+81) 3.3359.4306
FAX: (+81) 3.3359.4307

Life Fitness Iberia
Telephone : (+34) 93 672 4660
FAX : (+34) 93 672 4670

7 SPECIFICATIONS

7.1 LIFE FITNESS STAIRCLIMBER SPECIFICATIONS

Designed use:	Heavy/Commercial
Maximum user weight:	350 pounds / 159 kilograms
Minimum user weight:	100 pounds / 45.3 kilograms
CONSOLE:	
Displays:	MESSAGE CENTER with heart rate, floors climbed, floors per minute, calories, calories per hour (if enabled), Watts (if enabled), and Mets (if enabled) WORKOUT PROFILE TIME/LEVEL WINDOW
Summaries:	Total elapsed time of workout, total calories burned, total floors climbed
Character size:	0.54 inches
WORKOUTS and GOALS:	Quick Start, Fat Burn, Cardio, Manual, Random, Hill, Heart Rate Hill, Heart Rate Interval, Extreme Heart Rate, Around the World, Kilimanjaro, Interval, Speed Training, Cascades, Foothills, Watts (if enabled), Mets (if enabled), Personal Trainer Workouts (6 slots), Time in Zone Goal, Calories Goal, Distance Goal
Heart rate monitor:	Lifepulse system sensors Polar heart rate monitoring system Polar heart rate chest strap (optional)
Intensity levels:	20
Stepping speed range	2 - 13 floors per minute
Step pedal size	6 inches x 11 inches / 15.2 centimeters x 27.9 centimeters
Maximum step height	13.5 inches / 34.3 centimeters
Drive type:	Belt/alternator
Accessory Tray:	Standard
Color:	Slate gray with red and black accents
ASSEMBLED DIMENSIONS:	
Length	48 inches / 122 centimeters
Width	32 inches / 81.2 centimeters
Height	64 inches / 162.6 centimeters
Weight	165 pounds / 75 kilograms
SHIPPING DIMENSIONS:	
Length	52 inches / 132 centimeters
Width	37 inches / 94 centimeters
Height	32 inches / 81 centimeters
Weight	201 pounds / 91 kilograms

Life Fitness Technical Communications Manual Sign-off Form

To the **reviewer(s)**: After reviewing the manual(s), please sign your name on the line above your printed name to indicate your approval of the manual for printing. If you are not approving the manual for printing, please write down a brief explanation on the following pages and initial your comments.

Date:

April 1, 2002

Manual(s):

Stairclimber 9500HR (M051-00K20-A387)

Reviewer(s):

Anderson, Tim

Berg, Joseph

Bourbonnais, Ross

Jaskolski, Mike

Kallmayer, Craig

King, Susan

Mack, David

Oglesby, Gary

Simat, Ryan

Starkel, Julie

Wehrly, Robert

White, Eric

